

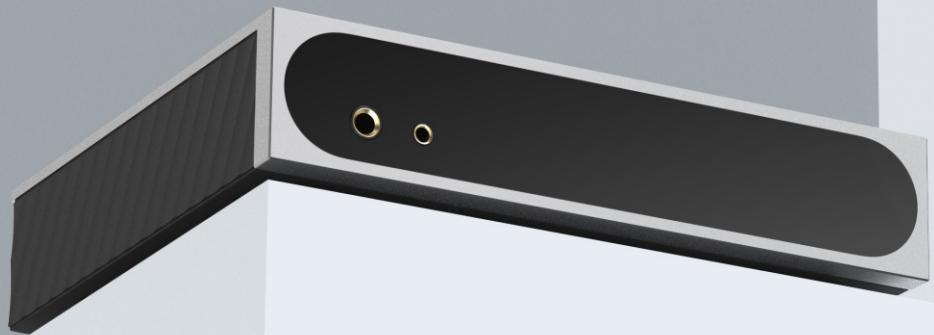

矩声®



mini-i Pro 4  
Music Streamer

# User Manual

<b>Packing list</b> . . . . .	<b>01</b>
<b>Parts and names</b> . . . . .	<b>02</b>
Top . . . . .	02
Front . . . . .	02
LCD Screen . . . . .	02
Rear . . . . .	03
Remote control. . . . .	04
<b>Operations before using</b> . . . . .	<b>05</b>
Connect to network . . . . .	05
MA Remote App . . . . .	05
Driver for USB Audio . . . . .	06
<b>Appendix</b> . . . . .	<b>08</b>
Technical specifications . . . . .	08
Power specifications . . . . .	09
Other specifications . . . . .	09
About MQA . . . . .	10
About Roon Ready . . . . .	10
About Spotify . . . . .	10

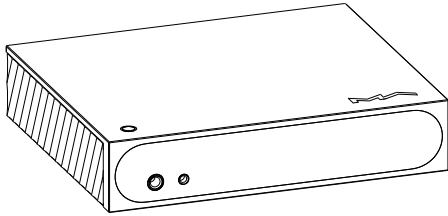

Product



Remote control

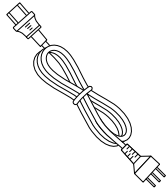

Power cable

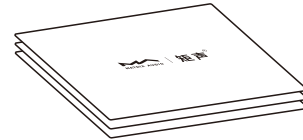

Quick start guide, warranty card

## Top

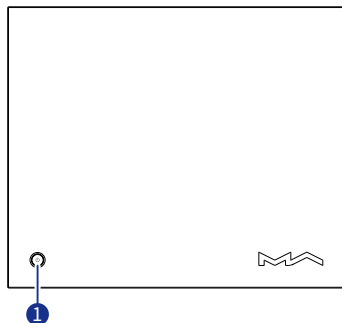
**1 Power on/Standby**

After connecting to the power supply, press this button to turn on the unit, hold the button for two seconds to standby. It takes about 30 seconds for the first start up after connecting to the power supply each time. When the device is working, press this button to mute, press again to unmute.

## Front

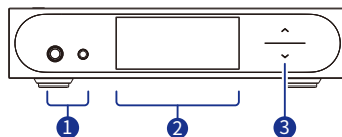
**1 Headphone jack**

The 6.35 mm headphone jack is for single-ended headphones, the 4.4 mm headphone jack is for balanced headphones.

**2 LCD screen****3 Volume key**

Tap on the arrow keys to change the volume step by step.

Hold the arrow keys for more than two seconds to change the volume rapidly.

## LCD screen

## Main information

**1 Media and audio information**

Including album art, track title, artist, duration, audio format, sampling rate of the track and the filter type being used.

**2 Input channel**

The name of selected input channel.

**3 Status bar**

Including status of clock and network connection.

**4 Output channel and volume**

The selected output channel and volume level.

## Operation of touch screen



Swipe right to open the shortcut page.

Swipe left to open the menu.

## Rear

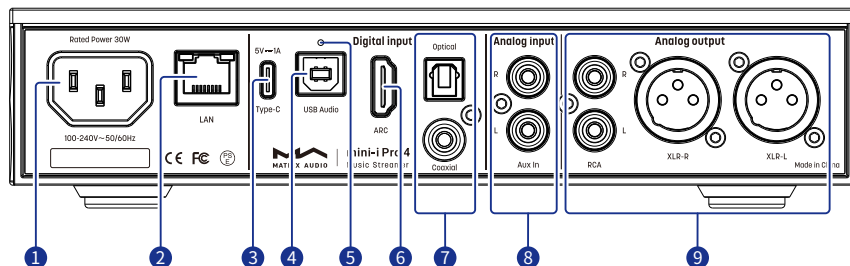
**1 AC input**

This unit adapts to AC100-240V power voltage range. Please make sure to use the product in the power voltage range mentioned above.

\*Please use the power cable which includes an earth wire. Please ensure you have a reliable earth wire connection. Otherwise, the casing of the unit may have a slightly charged touch. If you need the unit to be turned off completely, please unplug the power cable.

**2 Ethernet**

Connect to LAN port of the network router, the connection supports up to Gigabit Ethernet transmission.

**3 USB Type C**

Connect to USB storage devices which requires not higher than 5V/1A power supply.

**4 USB Audio**

Connect to computers, smart phones and tablets as external audio source devices through USB-B cables.

**5 Reset button**

Only use this button when the device works incorrectly, the device can be reset to factory state. Please operate under the instructions by service team from Matrix Audio.

**6 HDMI ARC**

Connect to TVs with ARC(Audio Return Channel)functionalities through HDMI cables.

**7 Optical & Coaxial input**

Connect to front-end devices with S/PDIF signal outputs through optical or coaxial cables.

**8 Analog input**

Connect to vinyl turntables or devices with analog outputs through RCA cables.

**9 Analog output**

Connect to active speakers or amplifiers through RCA or XLR cables.

## Remote control

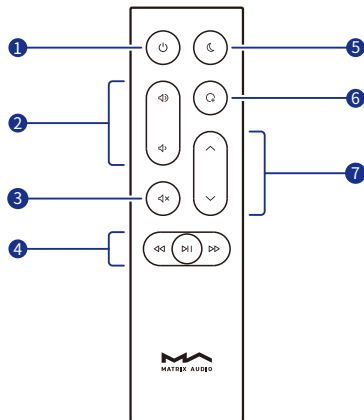
**1 Power on/Standby****2 Volume****3 Mute/Unmute**

Press to mute, press again to unmute. You also can unmute by pressing the  $\leftarrow/\rightarrow$  buttons in mute state.

**4 Playback control area**

When the input channel supports, the playback can be controlled by these buttons.

**5 Dimmer****6 Programmable button**

Define the functionalities of the programmable button through MA Remote App, the function is set to 'Filter' by default.

**7 Input channels**

The remote control uses a CR2032 battery. Slide the battery cover in the direction of the arrow to open the battery holder. Please pay attention to the polarities when installing the battery.

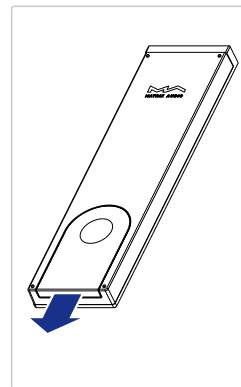
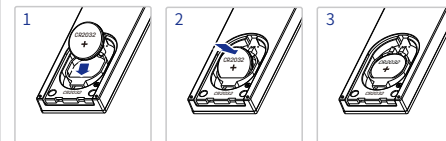
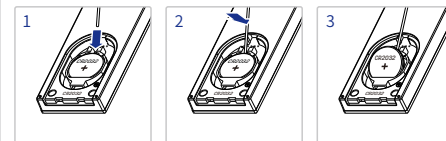
**Install a CR2032 battery****Remove the battery**

Point the remote control to the device when using it, the operating distance is about 8 meters. When the battery is low, there will be a message showing on the device display to notify you about replacing the battery.

If there are more than one Matrix Audio device in a single environment, in order to prevent 1 remote control from controlling multiple devices at the same time, we preset 5 sets of address codes in the remote control, these address codes can be configured in the Settings menu showing below, and follow the instructions on the device display.

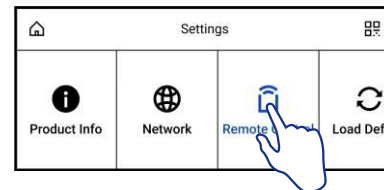

## Connect to network

### LAN

Connect the product to the LAN port of the network router through an Ethernet cable. It is recommended to set up the router as a DHCP server. The unit will be assigned an IP address automatically. Select "LAN" in option Network in Settings menu, after joining the network, there will be a  shown in the status bar.

### Wi-Fi

Enter Settings menu - Network - Wi-Fi, after network scanning complete, choose the SSID of your network and enter the passwords, there will be a  shown in the status bar after connected. The device supports 2.4GHz/5GHz wireless network.

When the connection has no Internet access, there will be a  in the status bar.

## MA Remote App

Install MA Remote App for your iPad, iPhone or Android phone.



Open the app, it will automatically search for the device and enter the home page after the device is added.

If you need to add the device manually, you can follow the prompts in the app wizard and scan the host QR code to add it manually.

\* Please make sure the device and your phone or iPad in the same network before connection.



To control and configure the device through MA Remote App, or playback streaming music from the element devices, please refer to [www.matrix-digi.com/tutorials](http://www.matrix-digi.com/tutorials) for instructions.



Tutorial Video

## Driver for USB Audio

When connecting the device to a Windows 7/8/10/11 computer via USB connection as an external audio device, please install drivers as following instructions:

1. Double-click the driver installation package and click "Next".

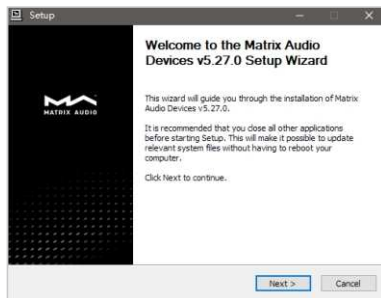

2. Select installation path and click "Install".

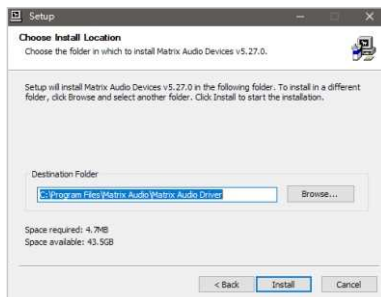

3. Click "Next" after the installation is complete.

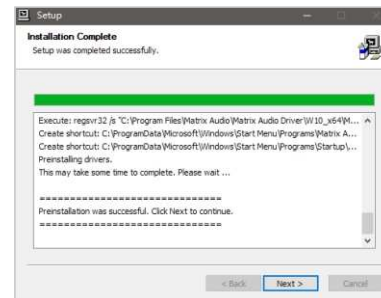

4. Click "Finish" to close the Setup Wizard.

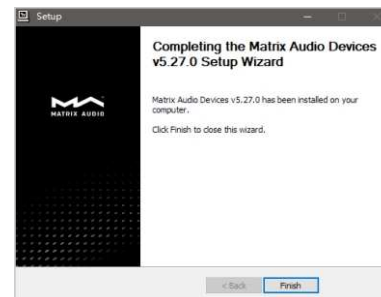



It's no need to install drivers for macOS, just select "mini-i Series" as the audio output device in Sound Preferences.



The device can be connected to an iPhone or iPad via a Lightning to USB Camera Adapter.

The device can be connected to Android devices via an OTG adapter, but not every Android devices are compatible with the device via OTG connection.

## Technical specifications

### Hardware Platform

CPU : Quad Cortex-A55 2.0GHz  
D/A Chip : ES9039Q2M

### Digital Input

#### COAXIAL & OPTICAL

PCM 16-24Bit/44.1kHz, 48kHz, 88.2kHz, 96kHz, 176.4kHz, 192kHz  
DSD 2.8MHz (DoP)

#### HDMI ARC

PCM 16-24Bit/44.1kHz, 48kHz, 88.2kHz, 96kHz, 176.4kHz, 192kHz

#### USB Audio

PCM 16-24Bit/44.1kHz, 48kHz, 88.2kHz, 96kHz, 176.4kHz,  
192kHz, 352.8kHz, 384kHz, 705.6kHz, 768kHz  
MQA 16-24Bit/44.1kHz, 48kHz, 88.2kHz, 96kHz, 176.4kHz,  
192kHz, 352.8kHz, 384kHz MQA or MQA Studio stream  
DSD 2.8MHz, 5.6MHz, 11.2MHz (DoP)  
DSD 2.8MHz, 5.6MHz, 11.2MHz, 22.4MHz (Native)

### Aux Input

SNR : 100dB A-weighting  
THD+N : <0.0035%@1k, <0.0035%@20Hz-20kHz  
Frequency Response : 20Hz-20kHz  $\pm 0.1$  -3dB@46kHz  
Channel Crosstalk : >-105dB  
Input Level : 2.1VRMS Maximum

### Line Output

XLR  
SNR : 127dB A-weighting  
THD+N : <0.00008%@1k, <0.00010%@20Hz-20kHz

Frequency Response : 20Hz-20kHz  $\pm 0.1$  -3dB@90kHz  
Crosstalk : >-146dB  
Output Level : 4.4VRMS@0dB

#### RCA

SNR : 121dB A-weighting  
THD+N : <0.00015%@1k, <0.00020%@20Hz-20kHz  
Frequency Response : 20Hz-20kHz  $\pm 0.1$  -3dB@90kHz  
Channel Crosstalk : >-133dB  
Output Level : 2.2VRMS@0dB

### Headphone Output

#### 4.4mm Balanced

SNR : 117dB A-weighting  
THD+N : <0.0004%@20Hz-20kHz 4VRMS  
Frequency Response : 20Hz-20kHz  $\pm 0.1$  -3dB@90kHz  
Output Impedance : <22 $\Omega$   
Output Power : 2200mW@33 $\Omega$ , 950mW@300 $\Omega$ , 500mW@600 $\Omega$ , 1%THD  
Gain : +14dB

#### 6.35mm Single-ended

SNR : 116dB A-weighting  
THD+N : <0.0005%@20Hz-20kHz 2VRMS  
Frequency Response : 20Hz-20kHz  $\pm 0.1$  -3dB@90kHz  
Output Impedance : <11 $\Omega$   
Output Power : 1200mW@33 $\Omega$ , 260mW@300 $\Omega$ , 130mW@600 $\Omega$ , 1%THD  
Gain : +14dB

### Network

LAN : 10/100/1000 Mbps  
WLAN : 2.4 GHz / 5 GHz

## USB Type C

The USB Type C port provides a maximum power of 5V/1A. The USB Type C port works with devices which conform to the USB mass storage standard and supports FAT, FAT32, exFAT, and NTFS file formats, but is not guaranteed to be compatible with all storage devices.

## MA Player

Controller app : MA Remote App

Local Playback :

Format Supported

MP3, WMA, WAV, AIF, AIFC, AIFF, AAC, FLAC, OGG, APE, ALAC, M4A, DSF, DFF, CUE

PCM 16-24Bit/44.1kHz, 48kHz, 88.2kHz, 96kHz, 176.4kHz, 192kHz, 352.8kHz, 384kHz, 705.6kHz, 768kHz

MQA 16-24Bit/44.1kHz, 48kHz, 88.2kHz, 96kHz, 176.4kHz, 192kHz, 352.8kHz, 384kHz MQA or MQA Studio stream

DSD 2.8MHz, 5.6MHz, 11.2MHz, 22.4MHz

Roon Ready:

PCM 16-24Bit /44.1kHz, 48kHz, 88.2kHz, 96kHz, 176.4kHz, 192kHz, 352.8kHz, 384kHz, 705.6kHz, 768kHz

MQA 16-24Bit/44.1kHz, 48kHz, 88.2kHz, 96kHz, 176.4kHz, 192kHz, 352.8kHz, 384kHz MQA or MQA Studio stream

DSD 2.8MHz, 5.6MHz, 11.2MHz, 22.4MHz

AirPlay 2, DLNA/UPnP, TIDAL Connect, Spotify Connect, vTuner, Radio Paradise, HIRESAUDIO, the audio specs depend on the service provider.

## Power specifications

Power Voltage : AC 100V-240V 50/60Hz

Standby Power Consumption : < 5W

Maximum Power Consumption : < 30W

## Other specifications

Weight : 1.3kg (2.87 pounds)

Size : Width 224 mm (8.80 inches)

Depth 186 mm (7.32 inches)

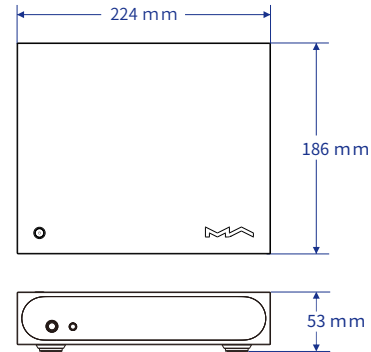

Height 53 mm (2.07 inches)



\*Specifications are subject to change without notice.

## About MQA (Master Quality Authenticated)

This unit includes a MQA full decoder, which enables you to playback MQA audio files via streaming or USB audio port, delivering the sound of the original master recording.

The dots beside the MQA logo green  or blue , to indicate that the unit is decoding and playing an MQA stream or file, and denotes provenance to ensure that the sound is identical to that of the source material. It glows blue  to indicate it is playing an MQA Studio file, which has either been approved in the studio by the artist/producer or has been verified by the copyright owner.

The dot glows magenta  to indicate that the unit is rendering an MQA stream or file. This delivers the final unfold of the MQA file.

\*MQA and the Sound Wave Device are registered trade marks of MQA Limited. ©2016

## About Roon Ready

Being Roon Ready means that Matrix Audio music streamers transparently discover and connect to Roon without any configuration, and bit-perfect audio is delivered from Roon to your music streamers.

## About Spotify

Use your phone, tablet or computer as a remote control for Spotify. Go to [www.spotify.com/connect](http://www.spotify.com/connect) to learn how.

The Spotify Software is subject to third party licenses found here:

<https://www.spotify.com/connect/third-party-licenses>

- This product is for indoor use only.
- For full ventilation, it is recommended to reserve a space of larger than 5 cm around the device.
- Do not cover the air vents with stuffs such as papers, tablecloths, and curtains to obstruct ventilation.
- Do not place stuff with flame, such as lighted candles, on the device.
- If the device is used in tropical areas, please be careful to prevent insects from entering the unit through the air vents.
- The device must not be subject to water droplets or splashes. Please do not place stuffs filled with liquids such as vases and cups on or near the device.
- Do not put stuffs around the device power plug and the AC power socket, in order to disconnect the power supply easily when needed.

# Into The Music

[www.matrix-digi.com](http://www.matrix-digi.com)

Matrix Electronic Technology Co., LTD  
+86-29-86211122  
Room 206 Block B, #58 Mingguang Rd,  
Xi'an, China

